

ZHQ55 拖链-安装尺寸及技术参数

ZHQ55 Cable Chain-Installation Dimensions and Technical Parameters

架空长度

Unsupported length

- L_G = 直线架空长度
- L_A = 安全塌腰架空长度
- L_G = Unsupported with straight upper run
- L_A = Unsupported with permitted sag

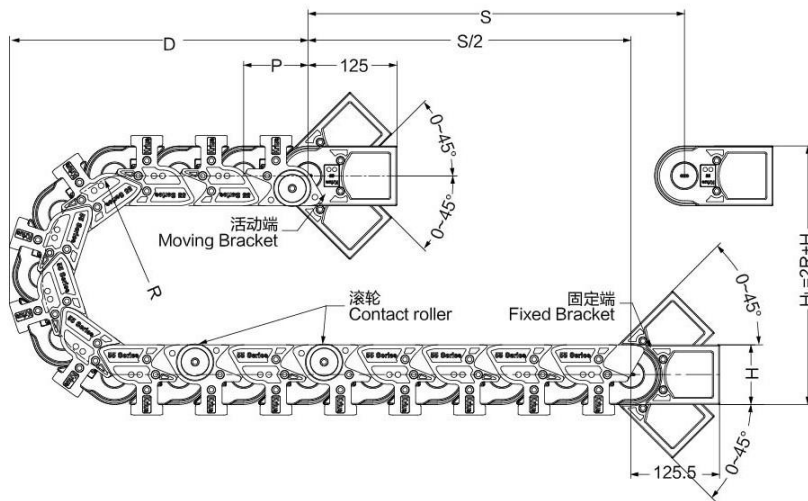
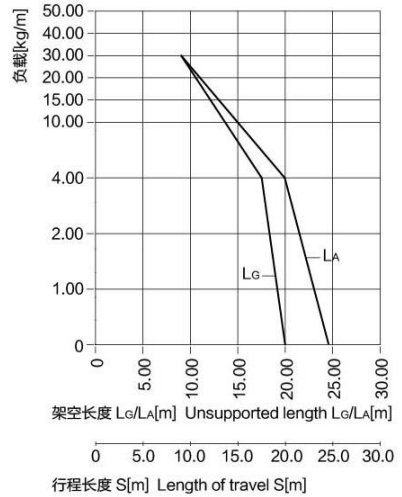
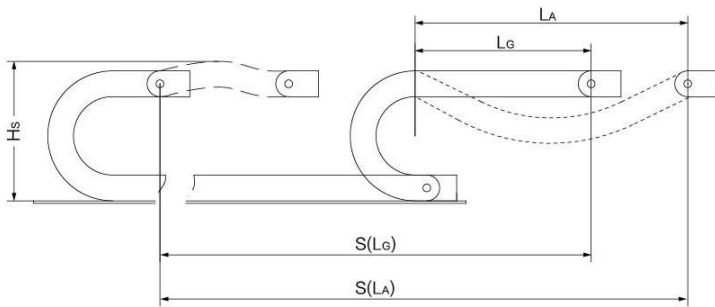

- S = 行程长度
- R = 弯曲半径
- P = 节距
- L = 拖链长度
- N = 每米链节数
- H_L = 理论安装高度
- H_s = 实际安装高度
- D = 拖链退回极限位置时的最小距离
- $K = \pi \cdot R + 2P$
- * K值可在科瑞斯相关表格中直接查询
- S = Length of travel
- R = Bending Radius
- P = Pitch
- L = Length of chain
- N = Links per meter
- H_L = Nominal clearance height
- H_s = Required clearance height
- D = Overlength Energy Chain radius in final position
- $K = \pi \cdot R + 2P$
- * You can find it from below chart for more details

R	H_L	D	K	P
130(5.12)	359(14.13)	270(10.63)	590(23.23)	91(3.58)
150(5.91)	399(15.71)	310(12.20)	655(25.79)	91(3.58)
175(6.89)	449(17.68)	360(14.17)	730(28.74)	91(3.58)
200(7.87)	499(19.65)	410(16.14)	810(31.89)	91(3.58)
225(8.86)	549(21.61)	460(18.11)	890(35.04)	91(3.58)
250(9.84)	599(23.58)	510(20.08)	970(38.19)	91(3.58)
300(11.81)	699(27.52)	610(24.02)	1125(44.29)	91(3.58)
350(13.78)	799(31.46)	710(27.95)	1280(50.39)	91(3.58)
400(15.75)	899(35.39)	810(31.89)	1440(56.69)	91(3.58)

实际安装高度: $H_s = H_L + 85\text{mm}$
 拖链长度: $L = S/2 + K$
 每米链节数: $N = 11$ (1001mm)

The required clearance height: $H_s = H_L + 3.35\text{in.}$
 Chain length: $L = S/2 + K$
 Links per meter: $N = 11$ (39.41in.)

技术参数 Technical Parameters		
速度/加速度 L_G	Speed/acceleration L_G	max.25[m/s]/max.205[m/s ²]
速度/加速度 L_A	Speed/acceleration L_A	max.5[m/s]/max.8[m/s ²]
滑行速度/加速度	Gliding speed/acceleration	max.5[m/s]/max.12[m/s ²]
材料-允许温度 °C	Material-permitted temperature	igumid G/-40°C至+125°C
阻燃等级, igumid G	Flammability Class, igumid G	VDE 0304 IIC UL94 V2

ZHQ55 拖链-产品规格范围 ZHQ55 Cable Chain-Product specifications

ZHQ55拖链-内外侧可开 ZHQ55 Cable Chain-Inner and outer can be opened

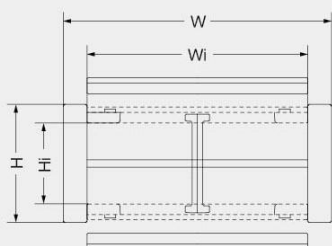

产品代码结构
Part Number Structure

ZHQ55100*R*L*n

数量 (Quantity)
拖链长度 (Length of Cable chains)
弯曲半径 (Bending Radius)
内宽 (Inner Width)
型号 (Type)

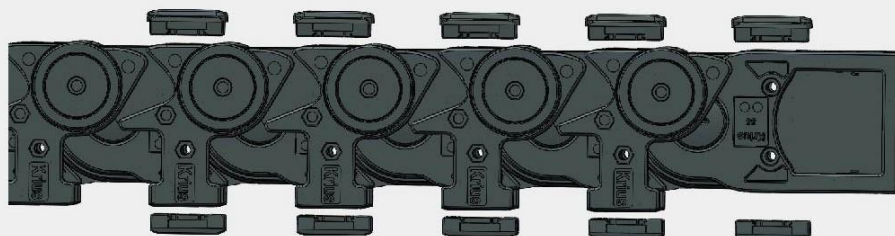

型号 Type	弯曲半径<R> Bending radius	内高<Hi> Inner height	内宽<Wi> Inner width	外高<H> Outer height	外宽<W> Outer Width	重量<G> Weight	备注 Remark
	mm (in.)	mm (in.)	mm (in.)	mm (in.)	mm (in.)	kg/m (lbs/ft)	
ZHQ5575			75 (2.95)		173 (6.81)	4.63 (3.15)	
ZHQ55100			100 (3.94)		198 (7.80)	4.84 (3.29)	
ZHQ55125			125 (4.92)		223 (8.78)	5.03 (3.42)	
ZHQ55150			150 (5.91)		248 (9.76)	5.21 (3.54)	
ZHQ55175			175 (6.89)		273 (10.75)	5.47 (3.72)	
ZHQ55200			200 (7.87)		298 (11.73)	5.68 (3.86)	
ZHQ55250			250 (9.84)		348 (13.70)	6.08 (4.13)	
ZHQ55300		55 (2.17)	300 (11.81)	99 (3.90)	398 (15.67)	6.46 (4.39)	
ZHQ55350			350 (13.78)		448 (17.64)	6.88 (4.68)	
ZHQ55400			400 (15.75)		498 (19.61)	7.33 (4.98)	
ZHQ55450			450 (17.72)		548 (21.57)	7.77 (5.28)	
ZHQ55500			500 (19.69)		598 (23.54)	8.21 (5.58)	
ZHQ55550			550 (21.65)		648 (25.51)	8.65 (5.88)	
ZHQ55600			600 (23.62)		698 (27.48)	9.09 (6.18)	

订货范例
Order details

ZHQ5575 * R100 * 1000mm * 2

R	HL	D	K	P
130 (5.12)	359 (14.13)	270 (10.63)	590 (23.23)	91 (3.58)
150 (5.91)	399 (15.71)	310 (12.20)	655 (25.79)	91 (3.58)
175 (6.89)	449 (17.68)	360 (14.17)	730 (28.74)	91 (3.58)
200 (7.87)	499 (19.65)	410 (16.14)	810 (31.89)	91 (3.58)
225 (8.86)	549 (21.61)	460 (18.11)	890 (35.04)	91 (3.58)
250 (9.84)	599 (23.58)	510 (20.08)	970 (38.19)	91 (3.58)
300 (11.81)	699 (27.52)	610 (24.02)	1125 (44.29)	91 (3.58)
350 (13.78)	799 (31.46)	710 (27.95)	1280 (50.39)	91 (3.58)
400 (15.75)	899 (35.39)	810 (31.89)	1440 (56.69)	91 (3.58)

ZHQ55 拖链-拖链接头 ZHQ55 Cable Chain-Mounting Bracket

塑料接头, 分体式 Plastic Mounting Bracket, Splitted structure

- 双侧独立式塑料接头
- 两端接头均可双向活动
- 耐腐蚀 & 耐摩擦
- 可提供预装配形式
- 可实现内外连接
- Independent Plastic mounting bracket on the two end
- Two end mounting bracket can be movable to upper and lower
- Anti-corrosion, Rub-resistance
- Available preassembly form
- Can realize the internal and external connections

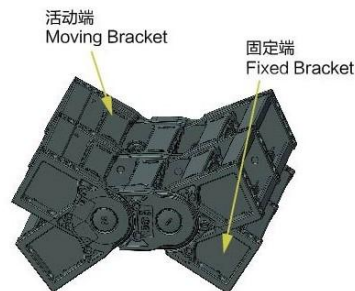

可选配的接头安装方式 Available installation methods

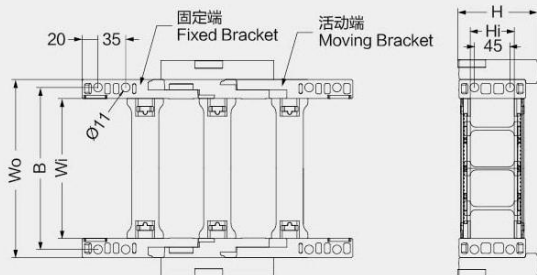
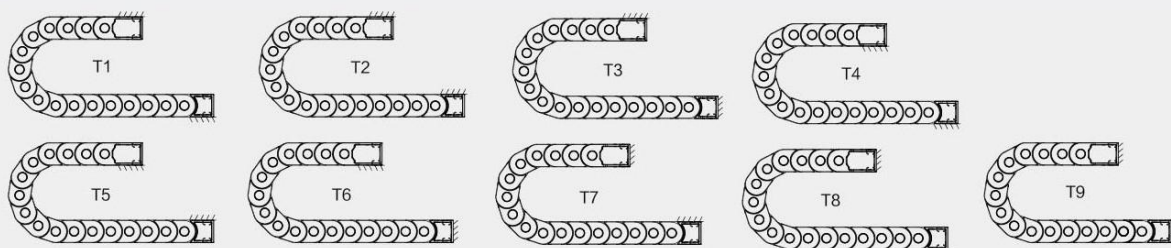

ZHQ5575 / ZHQ55100 / ZHQ55125 / ZHQ55150 / ZHQ55175
ZHQ55200 / ZHQ55250 / ZHQ55300 / ZHQ55350 / ZHQ55400
ZHQ55500 / ZHQ55550 / ZHQ55600

拖链型号 Type	拖链编码 Code	其他编码 Other Code	Wo尺寸 Dimension Wo	B尺寸 Dimension B
			mm (in.)	mm (in.)
ZHQ5575	13074	接头 Mounting Bracket	123 (4.84)	103 (4.06)
ZHQ55100	13075	主体 Separator	148 (5.83)	128 (5.04)
ZHQ55125	13076	竖隔离片 Vertical separator	173 (6.81)	153 (6.02)
ZHQ55150	13077	横隔离片 Horizontal separator	198 (7.80)	178 (7.01)
ZHQ55175	13078	横隔离片 Horizontal separator	223 (8.78)	203 (7.99)
ZHQ55200	13079	横隔离片 Transverse septum	248 (9.76)	228 (8.98)
ZHQ55250	13080	横隔离片 Transverse septum	298 (11.73)	278 (10.94)
ZHQ55300	13093	L400隔离杆 Separator of Length with 400mm	348 (13.70)	328 (12.91)
ZHQ55350	13085	滚轮 Contact roller	398 (15.67)	378 (14.88)
ZHQ55400	13102	轮架 Frame of wheels	448 (17.64)	428 (16.85)
ZHQ55450	13103	轴销 Axle pin	498 (19.61)	478 (18.81)
ZHQ55500	13103	轴销 Axle pin	548 (21.57)	528 (20.79)
ZHQ55550	13104	锁扣 Fixed Plate	598 (23.54)	578 (22.76)
ZHQ55600	13104	锁扣 Fixed Plate	648 (25.51)	628 (24.72)

产品代码结构 Part Number Structure

ZHQ55100*B*T1

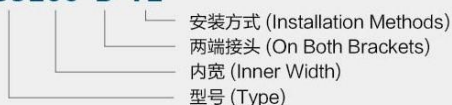

- ZHQ55100*B*T1*n 两端接头
On both brackets
- ZHQ55100*f*T1*n 固定端接头
Fixed bracket
- ZHQ55100*m*T1*n 移动端接头
Moving bracket

每款拖链的接头都有所不同, 订购时如有任何疑问, 请及时咨询科瑞斯。
Every bracket is different, please contact us if you have any question.

ZHQ55 拖链-隔离片 ZHQ55 Cable Chain-Separator

- 本款拖链配备的隔离元件为横隔离（插）片和竖隔离（插）片，可以实现垂直分割和水平分隔
- 隔离元件的数量可以根据客户的实际需求进行配备
- 竖隔（插）片可以根据线缆排布进行滑动
- The isolation element is equipped with horizontal chain (plug) and vertical isolation (plug), you can achieve vertical segmentation and horizontal partitioning
- The number of isolated components can be equipped according to the actual needs of customers
- Vertical separator can be moved for different cables

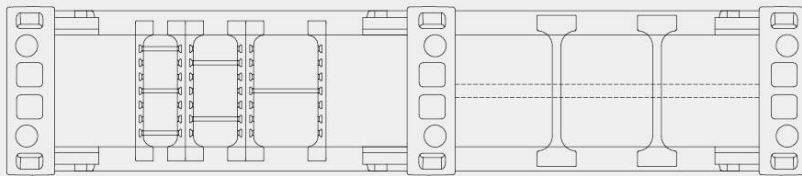

单位: mm

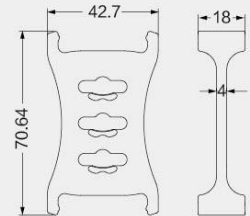
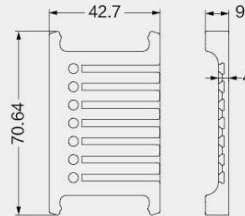
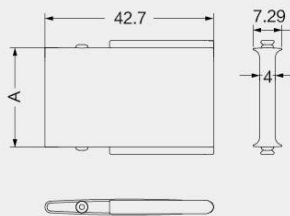
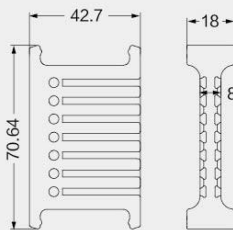

ZLQ55和ZHQ55共用
The separator No. for ZLQ55 and ZHQ55 are same parts:

- | | |
|---------------------------------|-------|
| ① 竖隔离片 (Vertical Separator) | 13089 |
| ② 横隔插片 (Transverse Septum) | 13087 |
| ③ 竖隔离片 (Vertical Separator) | 13089 |
| ④ 横隔插片 (Horizontal Separator) | 13086 |
| ⑤ 竖隔离片 (Vertical Separator) | 13089 |

注: ①②③之间的距离可以为25mm、30mm、40mm、50mm、60mm、70mm
Note: (1) (2) (3) the distance between the 25mm、30mm、40mm、50mm、60mm、70mm